

PROFILO BINARIO MAGNETICO
SOFFITTO/SOSPENSIONE

MAGNETIC TRACK PROFILE
CEILING/SUSPENSION



Binario magnetico elettrificato in classe III SELV 48Vdc. Realizzato in estruso di alluminio verniciato colore nero. Lunghezza 1.000, 1.500 e 2.000 mm. All'interno sono posizionati due cavi in rame per un carico massimo di 15 A e una lunghezza massima per singola tratta di 30 metri. Sono presenti altri due cavi in rame per eventuale segnale analogico 0-10V per la dimmerazione. Il binario è installabile a soffitto e sospensione utilizzando gli appositi accessori.

Class III SELV 48Vdc electrified magnetic track. Made of extruded aluminum. Black painted. Length 1.000, 1.500 and 2.000 mm. Inside there are two copper cables for a maximum load of 15 A and a maximum length of 30 meters per single section. There are two other copper cables for any 0-10V analog signal for dimming. The track can be installed on the ceiling and suspension using the appropriate accessories.

	<p>MT200CB</p>	<p>Binario magnetico lunghezza 2.000 mm.</p>	<p><i>Black magnetic track length 2.000 mm.</i></p>
	<p>MT150CB</p>	<p>Binario magnetico lunghezza 1.500 mm.</p>	<p><i>Black magnetic track length 1.500 mm.</i></p>
	<p>MT100CB</p>	<p>Binario magnetico lunghezza 1.000 mm.</p>	<p><i>Black magnetic track length 1.000 mm.</i></p>
	<p>MTPCCB</p>	<p>Accessorio singolo per montaggio binario a soffitto</p>	<p><i>Single accessory for ceiling rail mounting</i></p>
	<p>MTMFCB</p>	<p>Kit sospensione composto da due cavi in acciaio lunghezza 1,5m e dispositivi regolazione quick system</p>	<p><i>Suspension kit consisting of two steel cables length 1,5m and quick system adjustment</i></p>
	<p>MTLCCB + MTGL</p>	<p>Connettore a L completo di raccordi elettrici</p>	<p><i>L-shaped branch connector complete with electrical connections</i></p>
	<p>MTTCCB + MTGT</p>	<p>Connettore a T completo di raccordi elettrici</p>	<p><i>T-shaped branch connector complete with electrical connections</i></p>
	<p>MTXCCB + MTGX</p>	<p>Connettore a X completo di raccordi elettrici</p>	<p><i>X-shaped branch connector complete with electrical connections</i></p>
	<p>MTECCB</p>	<p>Testata di chiusura</p>	<p><i>End cap</i></p>

**ACCESSORI ELETTRICI
PER BINARIO MAGNETICO**

***ELECTRICAL ACCESSORIES
FOR MAGNETIC TRACK***



	MTAOB	Alimentatore ON-OFF	ON-OFF power supply for electrified track
	MTADB	Alimentatore dimming	Electrified track power supply for dimming light modules
	MTGL	Giunto lineare elettrico	Electric linear joint
	MTML	Giunto lineare meccanico	Mechanical linear joint
	MTT1100B	Trasformatore interno 100W 220V AC output 48Vdc	Compact transformer 100W 48Vdc ON-OFF for installation inside the track
	MTT2250B	Trasformatore interno 250W 220V AC output 48Vdc	Compact transformer 250W 48Vdc ON-OFF for installation inside the track
	MTT375B	Trasformatore esterno 60W 220V AC output 48Vdc	External transformer 60W input 220V AC output 48Vdc
	MTT4150B	Trasformatore esterno 150W 220V AC output 48Vdc	External transformer 150W input 220V AC output 48Vdc
	MTT5240B	Trasformatore esterno 240W 220V AC output 48Vdc	External transformer 240W input 220V AC output 48Vdc

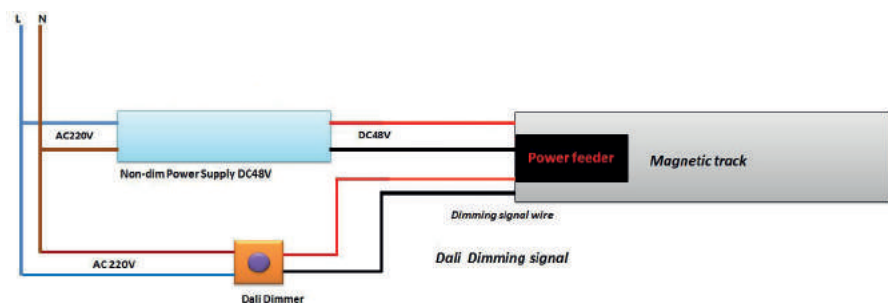

SCHERMO OPALE / OPAL SCREEN

MODULO LUCE SCHERMO OPALE

Modulo lineare in estruso di alluminio di colore nero.
Con schermo opale per una diffusione ampia e omogenea della luce.

OPAL SCREEN LIGHT MODULE

Linear module in black extruded aluminum.
With opal shade for a wide and homogeneous diffusion of light.



Item: MTOP7B-
Power: 7W
Beam angle: 110°
Output flux: 480 lm
Temp. Color: 3.000K
CRI: >90
Driver: on-off (F), Dali (D)
IP20, class III, F mark

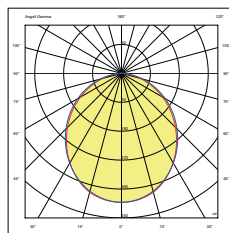
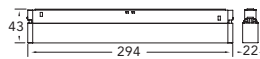

Item: MTOP15B-
Power: 15W
Beam angle: 110°
Output flux: 1050 lm
Temp. Color: 3.000K
CRI: >90
Driver: on-off (F), Dali (D)
IP20, class III, F mark

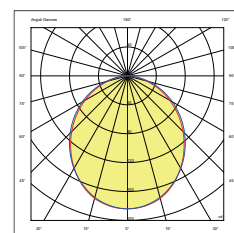
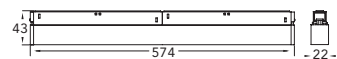

MULTI OTTICA / MULTI OPTICAL

MODULO LUCE MULTI OTTICA CONFORT

Modulo lineare in estruso di alluminio in colore nero.
Equipaggiato di 6 o 12 microottiche sfaccettate con schermo trasparente di chiusura e ottica secondaria nera.

COMFORT MULTI OPTICAL LIGHT MODULE

Linear module in extruded aluminum in black color.
Equipped with 6 for 12 faceted micro optics with transparent closing screen and black secondary optics.



Item: MTFM12B-
Power: 12W
Beam angle: 45°
Output flux: 761 lm
Temp. Color: 3.000K
CRI: >90
Driver: on-off (F), Dali (D)
IP20 , class III , F mark

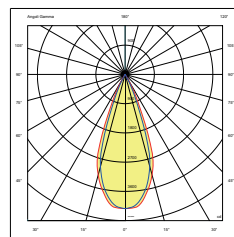
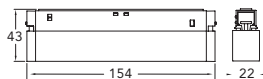

Item: MTFM24B-
Power: 24W
Beam angle: 45°
Output flux: 1584 lm
Temp. Color: 3.000K
CRI: >90
Driver: on-off (F), Dali (D)
IP20 , class III , F mark

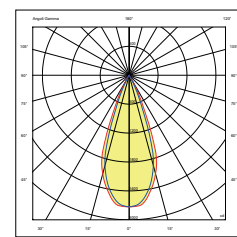
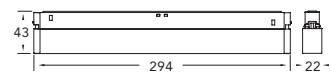



ORIENTABILE / ADJUSTABLE

MODULO LUCE MULTI OTTICA CONFORT ORIENTABILE

Modulo lineare in estruso di alluminio in colore nero. Equipaggiato di 6 o 12 micro-ottiche sfaccettate con schermo trasparente di chiusura e ottica secondaria nera. Orientabilità ortogonale rispetto al binario.

ADJUSTABLE COMFORT MULTI OPTICAL LIGHT MODULE

Linear module in extruded aluminum in black color. Equipped with 6 or 12 faceted micro-optics with transparent closing screen and black secondary optics. Adjustability orthogonal with respect to the track.



Item: MTGM12B-
Power: 12W
Beam angle: 45°
Output flux: 761 lm
Temp. Color: 3.000K
CRI: >90
Driver: on-off (F), Dali (D)
IP20, class III , F mark

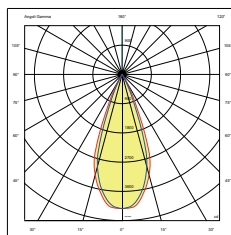
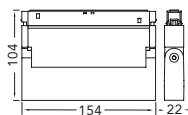

Item: MTGM24B-
Power: 24W
Beam angle: 45°
Output flux: 1584 lm
Temp. Color: 3.000K
CRI: >90
Driver: on-off (F), Dali (D)
IP20, class III , F mark

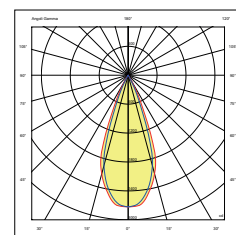
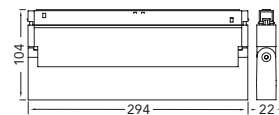



PROIETTORE PROJECTOR

PROIETTORE COMPATTO PER BINARIO MAGNETICO 48VDC.

Proiettore compatto di forma cilindrica in alluminio. Colore nero.
Completo di adattatore per binario magnetico 48Vdc. Disponibile nella versione ON-OFF e dimmerabile DALI su richiesta. Grado di protezione IP20, classe di isolamento III, marchio F.

COMPACT PROJECTOR FOR 48VDC MAGNETIC TRACK.

Compact cylindrical aluminum projector. Black color.
Complete with adapter for 48Vdc magnetic track. Available in the ON-OFF and analog 0-10V dimmable on request. Degree of protection IP20, insulation class III, F mark.



Item: MTPR8B-
Power: 8W
Beam angle: 36°
Output flux: 481 lm
Temp. Color: 3.000K
CRI: >90
Driver: on-off (F), Dali (D)
IP20 , class III , F mark



Item: MTPR20B-
Power: 20W
Beam angle: 36°
Output flux: 1.700 lm
Temp. Color: 3.000K
CRI: >90
Driver: on-off (F), Dali (D)
IP20 , class III , F mark

