

PIOGGIA

DESIGNER: TEAM DESIGN

TECHNICAL DATA SHEET

LS 1045/50P

Plafoniera con gocce in vetro cromato, struttura in cromo.
Illuminata con LED.

*Ceiling lamp with chromed glass drops, structure in chrome.
LED Light source.*

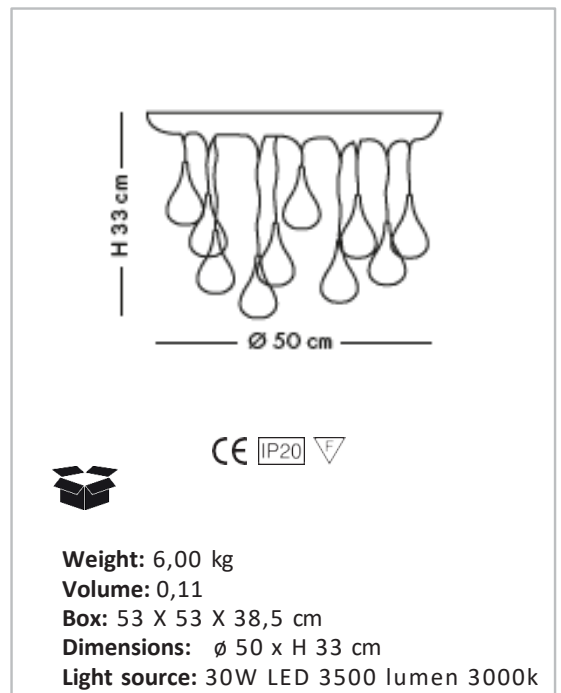

FINISHING

DIFFUSORE - LAMPSHADE



01
bianco
white

MONTATURA - FRAME



31
cromo
chrome